

# ROPER®

Home Appliances

# Use And Care

## G U I D E



**A Note To You** 2

**Important Safety Instructions** 3

**Parts And Features** 4

**Operating Instructions** 5

**Caring For Your Dryer** 13

**Laundry Guide** 17

**If You Need Assistance Or Service** 20

**Warranty** 24

Call TOLL-FREE With Questions or Comments: 1-800-44-ROPER

### LARGE CAPACITY ELECTRIC AND GAS DRYERS

**MODELS** EL4030V GL4030V  
EL5030V GL5030V  
EL6050V GL6050V

# A Note To You

## **Thank you for buying a Roper appliance.**

You have purchased a quality, *world-class* home appliance. Years of engineering experience have gone into its manufacturing. To ensure that you will enjoy many years of trouble-free operation, we have developed this Use and Care Guide. It is full of valuable information on how to operate and maintain your appliance properly and safely. Please read it carefully. Also, please complete and mail the Ownership Registration Card provided with your appliance.

## **Your safety is important to us.**

This guide contains safety symbols and statements. Please pay special attention to these symbols and follow any instructions given. Here is a brief explanation of the use of each symbol.

### **⚠ WARNING**

This symbol will help alert you to such dangers as personal injury, burns, fire and electrical shock.

### **⚠ CAUTION**

This symbol will help you avoid actions which could cause product damage (scratches, dents, etc.) and damage to your personal property.

## **Our TOLL-FREE number, 1-800-44-ROPER (1-800-447-6737), is available 24 hours a day.**

If you ever have a question concerning your appliance's operation, or if you need service, feel free to call us for help. When calling, you will need to know your appliance's complete model number and serial number. You can find this information on the model and serial number label (see diagram for your model on page 4 or 5). For your convenience, we have included a handy place below for you to record these numbers, the purchase date from the sales slip and your dealer's name and telephone number. Keep this book and the sales slip together in a safe place for future reference.

Model Number \_\_\_\_\_

Dealer Name \_\_\_\_\_

Serial Number \_\_\_\_\_

Dealer Phone \_\_\_\_\_

Purchase Date \_\_\_\_\_

### **FOR YOUR SAFETY**

**If you smell gas:**

- 1. Open windows.**
- 2. Don't touch electrical switches.**
- 3. Extinguish any open flame.**
- 4. Immediately call your gas supplier.**

### **FOR YOUR SAFETY**

**Do not store or use gasoline or other flammable vapors and liquids in the vicinity of this or any other appliance. The fumes can create a fire hazard or explosion.**

# Important Safety Instructions

## **⚠ WARNING**

To reduce the risk of fire, electrical shock, or injury to persons when using your dryer, follow basic precautions, including the following:

- **Read all instructions before using the dryer.**
- **NEVER** dry items cleaned, washed, soaked in or spotted with wax, paint, gasoline or flammable fluids in the dryer. The fumes can create a **FIRE HAZARD** or **EXPLOSION**. **ALWAYS** hand launder and air dry fabrics containing these materials.
- **NEVER** allow children to operate, play with or crawl inside the dryer. Close supervision of children is necessary when the dryer is used near children.
- **DO NOT** reach into a dryer if the drum is moving.
- When discarding an old dryer, **ALWAYS** remove the door to prevent accidental entrapment.
- **DO NOT** install or store dryer where it will be exposed to the weather.
- **DO NOT** tamper with the controls.
- **You are responsible for making sure that your dryer is installed, repaired and has parts replaced by a qualified person.**
- Use only fabric softeners specifically labeled as not being harmful to the dryer.
- **FIRE HAZARD** and **DAMAGE** to materials can result from:
  - drying rubber, rubber-like and heat sensitive materials with heat.
  - allowing lint build-up inside the dryer or exhaust system. Cleaning should be done periodically by a qualified person.
- Clean lint screen before or after each load.
- **DO NOT** let dust, lint, paper, rags, chemicals, etc. pile up around or under the dryer.
- Dryer must be electrically grounded. See the Installation Instructions.

– SAVE THESE INSTRUCTIONS –

## Additional safety instructions and your responsibilities

- **NEVER** operate the dryer if:
  - it is not working right (i.e. noisy, too hot).
  - it is damaged.
  - parts are missing (i.e. door latch).
  - all panels are not in place.
  - the lint screen is loose, damaged or missing.
- **ALWAYS** shut off the gas valve before leaving on vacation if you have a gas dryer.
- **ALWAYS** unplug the power supply cord or turn off electrical power before attempting to service the dryer. Shut off **GAS VALVE** if you have a gas dryer.
- **You are responsible for making sure that your dryer:**
  - is properly maintained.
  - is properly installed and leveled on a floor that can support the weight in a well ventilated room.\*
  - is located in an area where the temperature is above 45°F (7°C).
  - is connected to the proper outlet and electrical supply.\*
  - is properly connected to fuel and exhaust systems.\*
  - is not installed against drapes or curtains.\*
  - is used only for jobs normally expected of home clothes dryers.
  - is not used by anyone unable to operate it properly.

\*See the Installation Instructions for complete information.

# Parts And Features

Your dryer's parts and features are illustrated in this section. Become familiar with all parts and features before using your appliance.

## Models EL4030V and GL4030V

## Models EL5030V and GL5030V

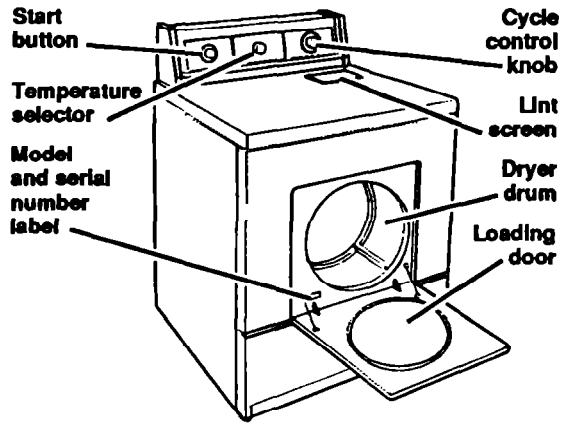
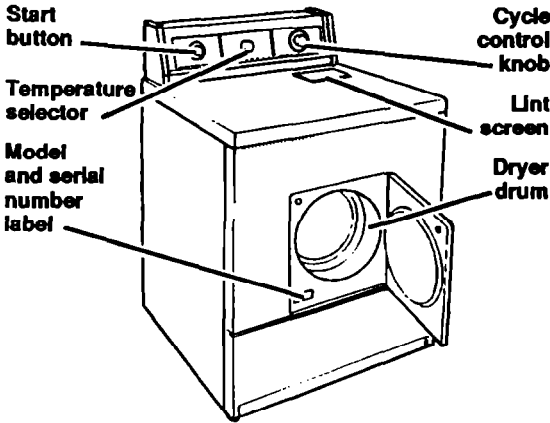

### Control panels EL4030V and GL4030V



### EL5030V and GL5030V

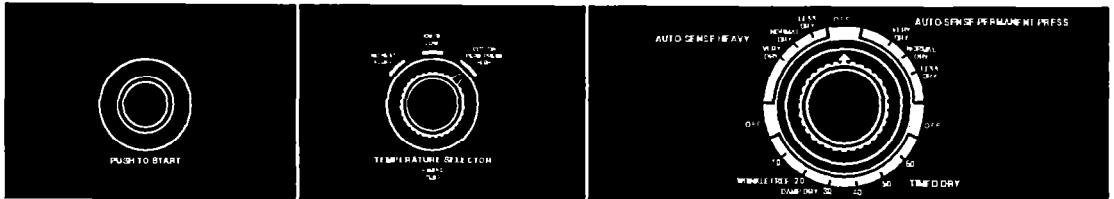

**Models EL6050V and GL6050V**

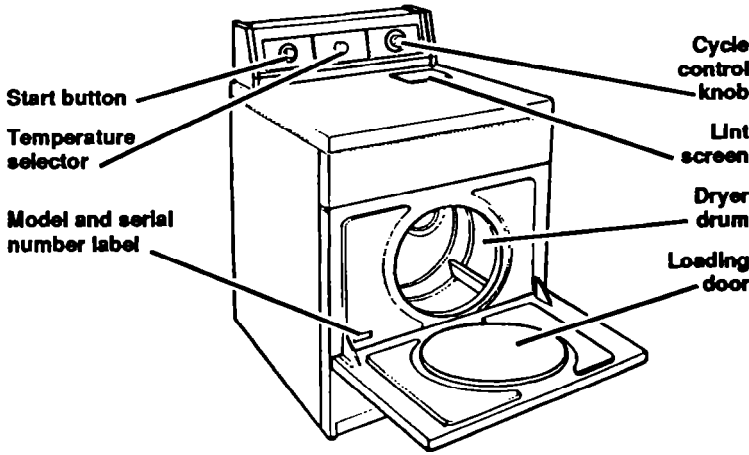

**Control panel  
EL6050V and GL6050V**

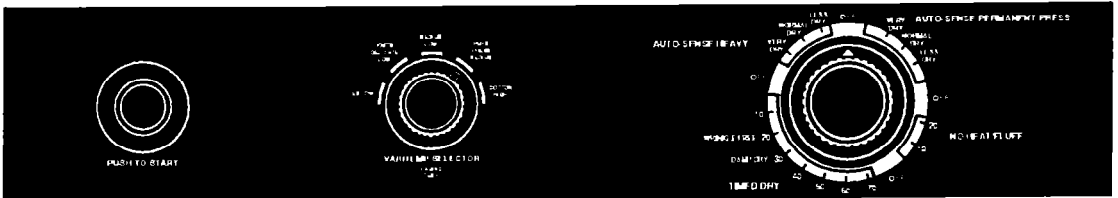

# Operating Instructions

In This Section		Page			Page
Starting your dryer .....	6	Using damp dry .....	11		
Cycles-EL4030V and GL4030V .....	9	The no heat fluff cycle or setting .....	11		
Cycles-EL5030V, GL5030V, EL6050V and GL6050V .....	9	End-of-cycle signal .....	12		
Using wrinkle free .....	10	Gentle heat system .....	12		

Your Roper dryer is designed for ease of operation and maximum drying efficiency. This section gives you important information for efficient and safe use of your dryer.

**NOTE:** Do not remove any permanent instruction labels inside the dryer. You should wipe out the dryer drum with a damp cloth before using to remove dust from storing or shipping.

If your dryer has a Consumer Buy Guide label, remove it. It will be easier to remove before the dryer is used. To remove any remaining glue:

- Rub briskly with thumb to make a ball, then remove.
- OR**
- Soak area with liquid hand dishwashing detergent before removing glue as described above.

Do not use sharp instruments, rubbing alcohol, flammable fluids or abrasive cleaners. These can damage the finish. See "Important Safety Instructions" on page 3.

## Starting your dryer

Be sure to refer to the chart below for proper sorting, loading and control setting information before starting your dryer.

**NOTE:** Do not overdry. Overdrying can cause shrinkage, static cling, and damage some fabrics.

TYPE OF LOAD	CYCLE TIME-TEMP (EL4030V, GL4030V)	CYCLE TIME-TEMP (EL5030V, GL5030V)	CYCLE TIME-TEMP (EL6050V, GL6050V)
<b>COTTONS AND LINENS</b>	<u>SPECIAL DRY</u>	<u>AUTO-SENSE HEAVY</u>	<u>AUTO-SENSE HEAVY</u>
Extra Heavy—Bedsreads, mattress pads, quilts	Ex Heavy-Normal	Cotton Perm't Press High	Cotton High
Heavyweight—Towels, jeans, corduroys, work clothes	Heavy-Normal	Cotton Perm't Press High	Cotton High
Mediumweight—Sheets, pillowcases, cotton underwear, diapers	Med-Normal	Cotton Perm't Press High	Perm't Press Medium
Lightweight—Batistes, organdies, lingerie	Light-Knits Low	Knits Low	Knits Delicate Low
<b>PERMANENT PRESS, SYNTHETICS AND BLENDS</b>	<u>PERMT PRESS</u>	<u>AUTO-SENSE PERMT PRESS</u>	<u>AUTO-SENSE PERMT PRESS</u>
Heavyweight—Work clothes, jackets, raincoats	40-50 min-Normal	Cotton Perm't Press High	Perm't Press Medium
Mediumweight—Shirts, play clothes, sheets, slacks	30-40 min-Normal	Cotton Perm't Press High	Perm't Press Medium
Lightweight—Lingerie, blouses, dresses	20-30 min-Knits Low	Knits Low	Medium Low
<b>KNITS</b>	<u>PERMT PRESS</u>	<u>AUTO-SENSE PERMT PRESS</u>	<u>AUTO-SENSE PERMT PRESS</u>
Heavyweight—Cottons, rayons, blends, T-shirts, slacks, shirts	40-50 min-Normal	Cotton Perm't Press High	Perm't Press Medium
Mediumweight—Synthetics (polyester, acrylic, etc.), dress slacks, skirts, sweaters	30-40 min-Normal	Knits Low	Medium Low
Lightweight—Synthetics (polyester, acrylic, etc.) and blends, lingerie, blouses, dresses	20-30 min-Knits Low	Knits Low	Knits Delicate Low
<b>DELICATE FABRICS</b>	<u>PERMT PRESS</u>	<u>AUTO-SENSE PERMT PRESS</u>	<u>AUTO-SENSE PERMT PRESS</u>
Sheer curtains (2 or 3 panels), gauze, lace, etc.	15-20 min-Knits Low	Knits Low	Ex Low
<b>⚠ WARNING</b>	<b>Fire Hazard</b>		
	Drying rubber, plastic and other heat-sensitive materials with heat can damage them or be a FIRE HAZARD.		
<b>RUBBER, PLASTIC, HEAT-SENSITIVE FABRICS</b>	<u>PERMT PRESS</u> No Heat Fluff *	<u>TIMED DRY</u> No Heat Fluff *	<u>NO HEAT/FLUFF **</u>
Foam Rubber—Pillows, bras, stuffed toys	20-30 min	20-30 min	20-30 min
Plastic—Shower curtains, tablecloths	20-30 min	20-30 min	20-30 min
Rubber-Backed rugs	40-50 min	40-50 min	40-50 min
Olefin, Polypropylene, Sheer nylon	15-20 min	15-20 min	15-20 min

\*See pages 11 and 12.

\*\*No temperature needs to be selected. Cycle is unheated.

1. **Select a cycle** by turning the Cycle Control Knob either way. Stop when the indicator on the knob's outer ring points to the cycle and time you want. See pages 9-12 for further cycle information.

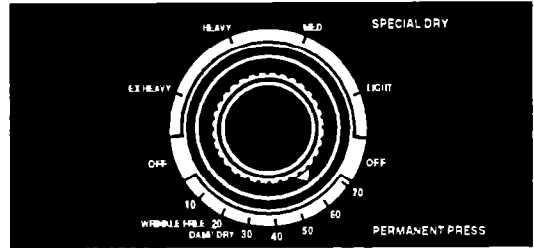

**EL4030V and GL4030V**

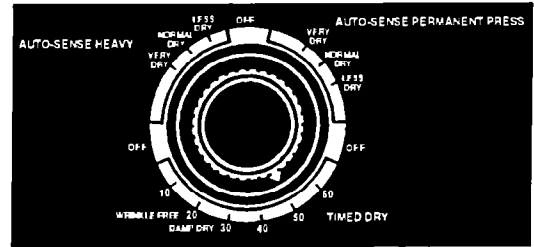

**EL5030V and GL5030V**

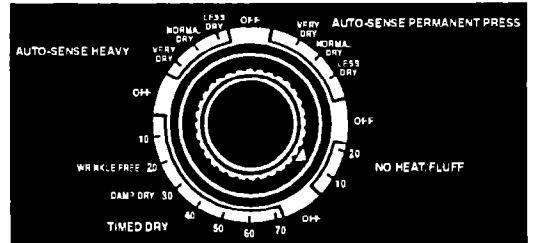

**EL6050V and GL6050V**

2. Set the Temperature Selector on the desired temperature setting. See chart on page 6 for more information.

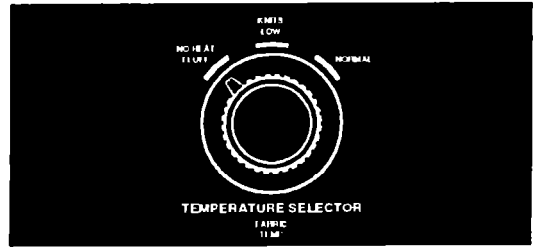

**EL4030V and GL4030V**

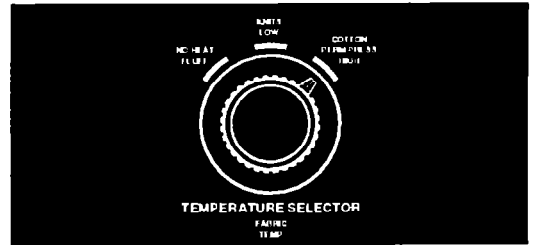

**EL5030V and GL5030V**

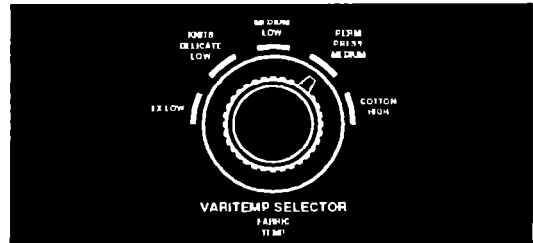

**EL6050V and GL6050V**

3. Push the Start Button to start the dryer.

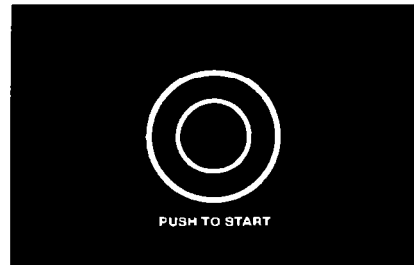

**To stop and restart the dryer:**

- Open the door or turn the Cycle Control Knob to OFF to stop the dryer.
- Close the door, select a cycle (if necessary) and push the Start Button to restart the dryer.

**To change the cycle and/or time,** turn the Cycle Control Knob either way to point to a new setting. The Cycle Control Knob should point to an OFF area when the dryer is not in use. If the dryer is stopped before the cycle is finished turn the Cycle Control Knob to an OFF area.



## Cycles-EL4030V and GL4030V

### Regular cycles

The regular cycles describe the types of loads they are designed to dry. Each cycle is followed by a 5 minute cool-down period. During the cool down, the load tumbles without heat. This helps make the load easier to handle.

Use **EX HEAVY** to dry items such as bedspreads, mattress pads and quilts.

Use **HEAVY** to dry such items as towels, jeans, corduroys and work clothes.

Use **MED** to dry items such as sheets, pillowcases, cotton underwear and diapers.

Use **LIGHT** to dry batistes, organdies and lingerie.

For the first few loads, set the Cycle Control Knob to point to a line in **SPECIAL DRY**. When the dryer stops, feel the dried items.

- If the items are drier than you like, set the Cycle Control Knob more to the right the next time you dry a similar load.
- If the items are not as dry as you like, set the Cycle Control Knob more to the left the next time you dry a similar load.

**NOTE:** Overdrying can cause shrinkage, static cling and damage to some fabrics.

### The PERMANENT PRESS cycle

The **PERMANENT PRESS** cycle helps provide the special care that permanent press and synthetic fabrics need. The cycle consists of a timed period of heated drying and a 10 minute cool-down period. During the cool down, the load tumbles without heat. This helps keep wrinkles from setting and makes the load easier to handle.

**NOTE:** To help reduce wrinkling, remove the load from the dryer as soon as tumbling stops. This is important for permanent press, knits and synthetic fabrics.

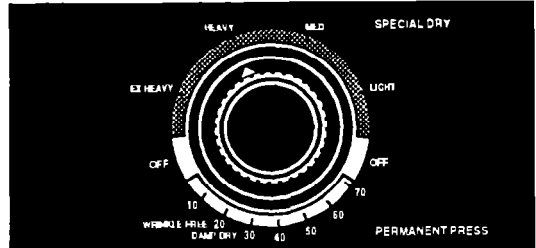

**EL4030V and GL4030V**

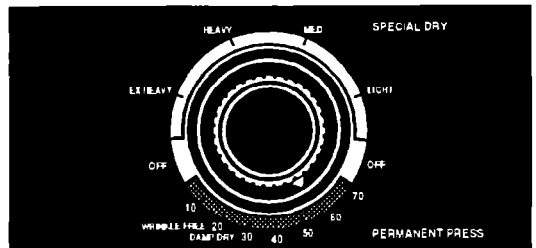

**EL4030V and GL4030V**

## Cycles-EL5030V, GL5030V, EL6050V and GL6050V

### The automatic cycles

The automatic cycles let you select the degree of dryness you want. A thermostat senses the air temperature and automatically shuts the dryer off when the selected dryness is reached.

Use **AUTO-SENSE HEAVY** to dry heavy and mediumweight cotton items. The load tumbles without heat during the last 5 minutes. This helps make the load easier to handle.

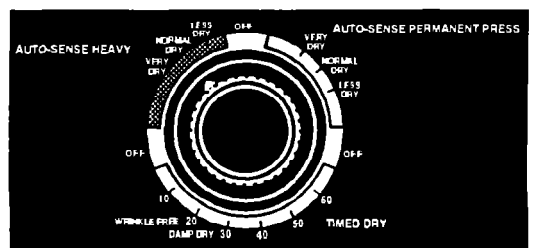

**EL5030V and GL5030V**

Use **AUTO-SENSE PERMANENT PRESS** to dry permanent press, knits and other synthetic items. The load tumbles without heat during the last 10 minutes. This helps keep wrinkles from setting in and makes the load easier to handle.

For the first few loads, set the Cycle Control Knob to point to **NORMAL DRY** in either automatic cycle. When the dryer stops, feel the dried items.

- If the items are drier than you like, set the Cycle Control Knob more to the right of **NORMAL DRY** the next time you dry a similar load.
- If items are not as dry as you like, set the Cycle Control Knob more to the left of **NORMAL DRY** the next time you dry a similar load.

**NOTE:** Overdrying can cause shrinkage, static cling and damage to some fabrics.

## TIMED DRY

Use the **TIMED DRY** cycle for any load you want to dry by time.

Turn the Cycle Control Knob to the number of minutes you want from 10 to 60 or 70. The last 5 minutes of this cycle are without heat to help make the load easier to handle.

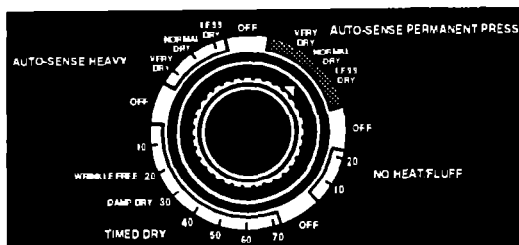

EL6050V and GL6050V

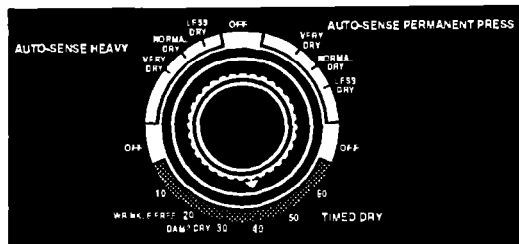

EL5030V and GL5030V

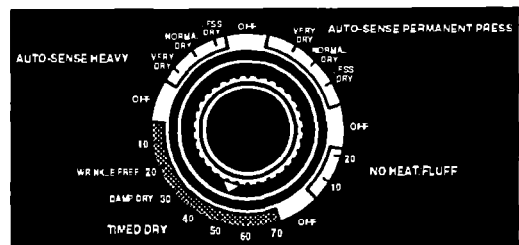

EL6050V and GL6050V

## Using WRINKLE FREE

The **WRINKLE FREE** setting removes wrinkles from clothing that has been packed in a suitcase or closet, and from items not removed from the dryer at the end of a cycle.

1. Set the Cycle Control Knob on **WRINKLE FREE**.
2. Set the Temperature Selector on **KNITS LOW** or **KNITS DELICATE LOW**.
3. Push the Start Button.

The load will tumble in heated air for 15 minutes. Then the dryer will tumble the clothes for 5 more minutes without heat.

For best results, put only a few items at a time in this cycle. As soon as the dryer stops, put the items on hangers or fold them.



## Using DAMP DRY

Use this setting to damp dry items that do not require an entire drying cycle, or to dry items to damp level. (Two examples are heavy cottons, such as jeans, which you do not want to become stiff, or cotton clothes which are easier to press when damp.)

1. Set the Cycle Control Knob on DAMP DRY.
2. Push the Start Button.

The load will tumble in heated air for 20 minutes, then without heat for 10 minutes.



## The NO HEAT FLUFF cycle or setting

### **⚠ WARNING**

#### **Fire Hazard**

Do not dry plastic or rubber items with heat. Use NO HEAT FLUFF, or line dry.

Failure to do so could result in fire or damaged items.

The dryer does not heat when the Temperature Selector is turned to NO HEAT FLUFF (EL4030V, GL4030V, EL5030V and GL5030V), or the Cycle Control Knob is turned to NO HEAT/FLUFF (EL6050V and GL6050V).

NO HEAT FLUFF can be used to fluff or air dry bedding, plastic tablecloths, foam rubber pillows, stuffed toys, sneakers, etc.

### For models EL4030V and GL4030V

Turn the Temperature Selector to NO HEAT FLUFF and the Cycle Control Knob to the number of minutes you want in the PERMANENT PRESS cycle. Then push the Start Button.

**NOTE:** Repeat above steps if more time is needed.

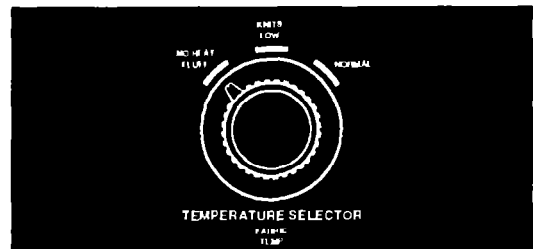

**EL4030V and GL4030V**

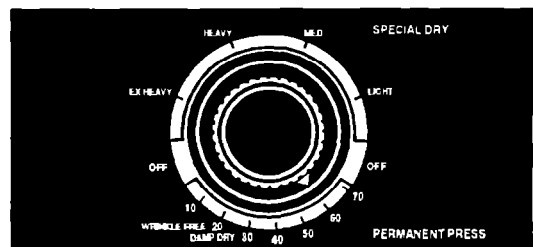

**EL4030V and GL4030V**

## For models EL5030V and GL5030V

Turn the Temperature Selector to NO HEAT FLUFF and the Cycle Control Knob to the number of minutes you want in the TIMED DRY cycle. Then push the Start Button.

**NOTE:** Repeat above steps if more time is needed.

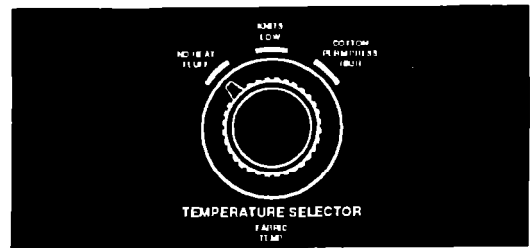

EL5030V and GL5030V

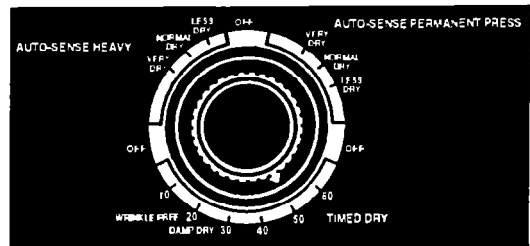

EL5030V and GL5030V

## For models EL6050V and GL6050V

Turn the Cycle Control Knob to the desired minutes you want in the NO HEAT/FLUFF cycle. Then push the Start Button.

**NOTE:** Repeat above steps if more time is needed.

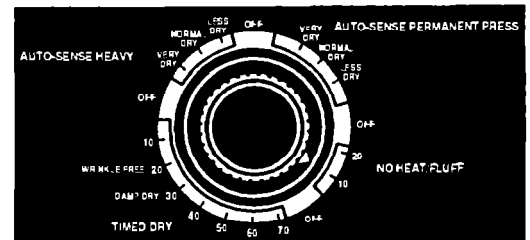

EL6050V and GL6050V

## End-of-cycle signal

### For models EL6050V and GL6050V

The dryer sounds a signal to let you know when the cycle is finished. The signal cannot be turned off and is not adjustable.

The signal is helpful when you are drying permanent press, synthetics and other items that should be taken out as soon as the dryer stops.

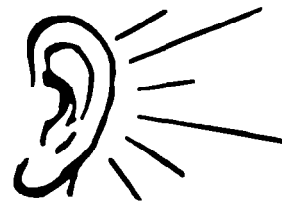

## Gentle Heat system

### For models EL6050V and GL6050V

For better fabric care, the Gentle Heat system helps prevent overdrying. Drying temperatures are automatically reduced to a lower heat setting during the last few minutes of drying.

Gentle Heat is followed by a cool-down period in all cycles to make your clothes easier to handle.

# Caring For Your Dryer

## In This Section

	Page		Page
Cleaning the lint screen .....	13	Cleaning the dryer .....	14
Lint screen maintenance .....	13	Lint removal .....	15

## ⚠ CAUTION

### Product and Fabric Damage Hazard

Do not run the dryer with the lint screen loose, damaged, blocked or missing. Doing so can cause overheating and damage to both the dryer and fabrics.

## Cleaning the lint screen

The lint screen is located under a lid on top of the dryer. Clean it before each load. A screen blocked by lint can increase drying time.

1. Open the lid and pull the lint screen straight out.
2. Roll lint off the screen with your fingers. Do not rinse or wash the screen to remove lint. Wet lint is hard to remove.
3. Push the lint screen firmly back into place and close the lid.

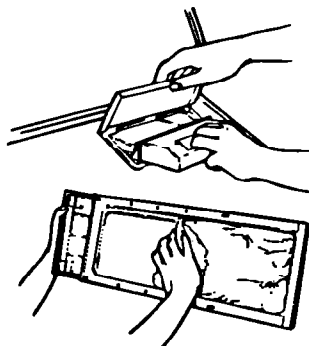

## Lint screen maintenance

Laundry detergents and fabric softeners can cause a residue build-up on the lint screen. A clogged lint screen can extend drying times. Clean the lint screen every six months or more frequently if it becomes clogged due to a residue build-up. Use the following method:

1. Wet both sides of lint screen with hot water.
2. Wet a nylon brush with hot water and liquid detergent.
3. Scrub lint screen with the brush until all residue build-up is removed.
4. Rinse with hot water.
5. Thoroughly dry lint screen with a clean towel and replace in dryer.

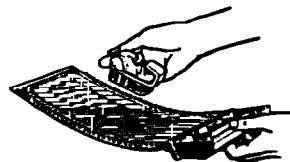

## Cleaning the dryer

### **⚠ WARNING**

#### **Electrical Shock and Personal Injury Hazard**

- Turn off the electrical power before cleaning the interior.
  - Make sure the dryer is cool.
- Failure to do so could result in electrical shock or injury.

#### **Fire Hazard**

- Use non-flammable cleaner.
- Failure to do so could result in an explosion.

Garments which contain unstable dyes, such as denim blue jeans or brightly colored cotton items, may discolor the dryer interior.

### **If you want to remove stains from dryer drum use one of the following methods:**

#### **Powdered laundry detergent**

1. Make a paste with detergent and very warm water.
2. Apply paste to a soft cloth and scrub area until all excess dye is removed.
3. Wipe thoroughly with a damp cloth.
4. Tumble a load of rags to dry.

#### **Liquid non-flammable household cleaner**

1. Apply to stained area.
2. Rub with a cloth until all excess dye is removed.
3. Wipe thoroughly with a damp cloth.
4. Tumble a load of rags to dry.

### **To clean dryer exterior:**

Wipe with a soft, damp cloth.

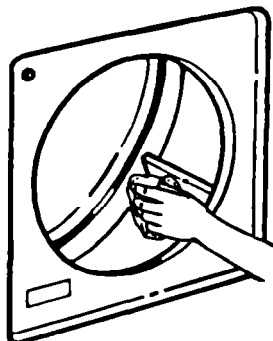

## Lint removal

Lint can gather inside the dryer and be a fuel for fire. It is recommended the lint be removed every 2 to 3 years, or more often, depending on dryer usage. Cleaning should be done by a qualified person. If you have any questions, please call our Consumer Assistance Center at 1-800-447-6737.

### **⚠WARNING**

#### **Electrical Shock and Personal Injury Hazard**

- Unplug the power supply cord or turn off the electrical power before removing dryer panels.
- Make sure the dryer is cool.
- Dryer parts can have sharp edges. Use care when handling.
- When replacing front panel after lint removal, the wire clips holding the door switch wires must be anchored to top of front and side panels. Wires **MUST NOT** touch rotating drum. (See page 16, step 7.)

Failure to do so could result in electrical shock or personal injury.

### **If your dryer is electric, or is gas and has a lower front access panel:**

1. Unplug the power supply cord or turn off the electrical power.
2. Remove back panel (electric) or lower front access panel (gas). See Installation Instructions.
3. Remove lint from shaded area in illustration with a soft brush or vacuum cleaner. Avoid damaging wires, thermostats (electric), funnel (gas) or igniter (gas).
4. Replace panel; reconnect and level dryer again, if necessary.

**NOTE:** See page 16 if your dryer is gas and has a full front panel.

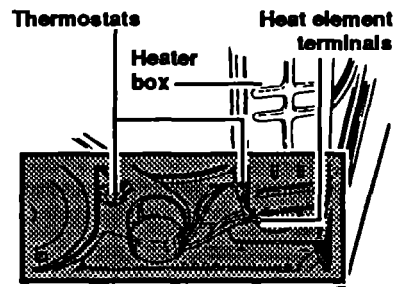

Electric dryer with back panel removed

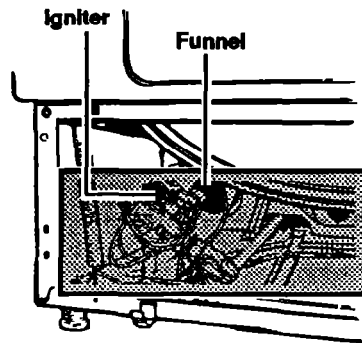

Gas dryer with lower front access panel removed

## If your dryer is gas and has a full front panel, remove front panel as follows:

1. Unplug the power supply cord or turn off the electrical power.
2. Open lint screen lid. Remove two screws from lint screen area.
3. Open top by pulling forward and up at each front corner (see view A). Rest raised top against wall behind dryer (top is hinged at rear).
4. Remove two internal screws from front panel flanges (near top front corners). Lift front panel slightly, lifting off lower clips (see view B). Slowly pull front panel forward, disengaging panel from drum. (Drum will drop slightly.)
5. Move front panel aside and rest edge against side of dryer. Avoid disconnecting wire clips (see view C) or damaging wires.
6. Remove lint from area shown in "gas dryer" illustration on page 15 with soft brush or vacuum cleaner. Avoid damaging wires, funnel or igniter.
7. Reassemble in reverse order. Before closing the top, check the following:
  - Drum seal must be flared out (see view D) and properly positioned against panel at back of drum. Rotate drum counterclockwise one full turn to check drum seal.
  - Belt should be centered and tight on dryer drum.
  - Wire clips which hold the door switch wires must be anchored in slot in top of front panel (see view C) and along top edge of side panel. Door wires must not touch drum when dryer is operating. **See Warning, page 15.**
8. Replace top panel and lint screen screws. Top and front panels must be securely in place before operating dryer.
9. Reconnect power and level dryer again (if necessary).

Remove screws before opening top

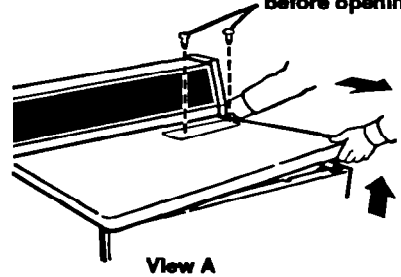

View A

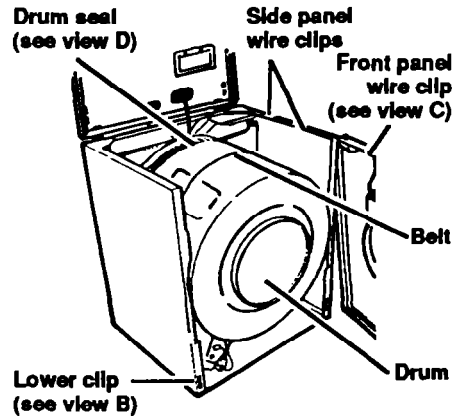

Lower clip (see view B)

Wire clip holds door switch wires

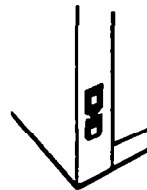

View B

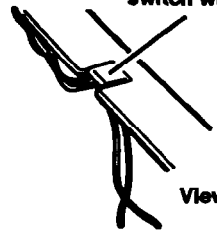

View C

**NOTE:** Call Consumer Assistance at 1-800-447-6737 for assistance or more information.

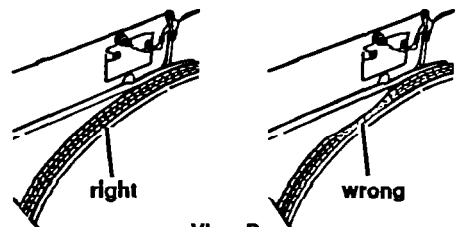

View D



# Laundry Guide

## In This Section

	Page		Page
Common laundering problems .....	17	Energy saving tips .....	19
Drying tips .....	19	Vacation care .....	19
Dryer fabric softeners .....	19		

This section will help you solve laundry problems and improve your drying results.

## Common laundering problems

PROBLEM	CHECK IF	CAUSES/SOLUTIONS
<b>Greasy spots</b>	<p>Dryer fabric softeners were used</p> <p>Undiluted washer fabric softener was used</p> <p>Enough detergent was used</p> <p>Items were clean before they were dried</p>	<p>Follow manufacturer's product directions carefully.</p> <p>Dilute fabric softener before adding to the final rinse.</p> <p>Use enough detergent to hold soil in the wash water until it drains away. Undrained soil can stick to outer tub of the washer and cause greasy spots with next load.</p> <p>Soiled items can stain other items in the load. They can also leave stains on the dryer drum that can be picked up by items in later loads. Dryer heat may permanently set these stains.</p>
<b>Lint</b>	<p>Lint screen is clogged</p> <p>Load is properly sorted</p> <p>Static electricity is attracting lint</p> <p>Load is too big or heavy</p> <p>Paper or tissue was in pocket</p> <p>Enough detergent was used</p> <p>Pilling is being mistaken for lint</p>	<p>Clean lint screen. (See page 13.)</p> <p>Sort lint-givers (bath towels, etc.) from lint-takers (synthetics, permanent press).</p> <p>Use fabric softener in the washer's final rinse. Use correct dryer settings for fabric. Overdrying synthetics can cause lint-attracting static electricity.</p> <p>Dry smaller loads. When items can't tumble freely, air is unable to carry lint to lint screen.</p> <p>Empty pockets carefully. A small scrap of paper can cause a lot of lint.</p> <p>Use enough detergent to hold the lint in the water until it drains away. Base detergent amount on water hardness and soil in wash load.</p> <p>Pilling (surface fuzz) is caused by normal wear and laundering. Pills do not break away easily from the fabric and can often collect lint. Synthetic fabrics are more likely to pill than others, especially at neckbands, elbows and knees.</p>

continued on next page

# LAUNDRY GUIDE

PROBLEM	CHECK IF	CAUSES/SOLUTIONS
<b>Shrinking</b>	<p>Items are overdried</p> <p>Fabric type and quality is suitable for drying</p>	<p>Remove items while there is still a trace of moisture. Some items should be removed while damp, then shaped and air dried.</p> <p>Some knits are stretched during manufacturing. Washing and drying returns them to the original size. This is normal. Check quality of garment before buying. Follow fabric care label directions carefully.</p>
<b>Slow drying</b>	<p>There is a large amount of moisture in the load to be dried</p> <p>Cold rinse water is used</p> <p>Room air temperature is below 45°F (7°C)</p> <p>Dryer is exhausted according to Installation Instructions</p> <p>Lint screen is clogged</p> <p>Exhaust duct or outside exhaust hood is clogged</p> <p>Proper electrical supply is used</p>	<p>Some items hold more moisture than others (cottons more than polyester). They take longer to dry. Full loads take longer to dry than small loads of the same fabric.</p> <p>A load rinsed in cold water will take slightly longer to dry than a warm one. Cold rinses, however, help save energy and reduce wrinkling more than warm rinses do.</p> <p>Install dryer in a room where the air temperature is warmer than 45°F (7°C). Cold air increases drying time and may cause wrinkles not to be removed.</p> <p>Install and exhaust your dryer according to the Installation Instructions provided.</p> <p>Clean lint screen before or after each use.</p> <p>Clean if needed.</p> <p>Properly connect the dryer to a grounded electrical circuit that meets the electrical requirements stated in the Installation Instructions.</p>
<b>Static electricity</b>	<p>Load is overdried</p> <p>Fabric softener is used</p> <p>Synthetics, synthetic blends, permanent press and knits are in load</p>	<p>Remove items while there is still a trace of moisture.</p> <p>Use fabric softener and follow package directions carefully.</p> <p>Synthetics, synthetic blends, permanent press and knits build up static electricity. Use a fabric softener and be careful not to overdry the load.</p>

---

## Drying tips

- Articles to be ironed should be removed from the dryer while still damp.
- Dry only clean items. Soiled items can leave stains on the dryer drum. These stains can be picked up by other items in the load. Dryer heat may permanently set some stains.

---

## Dryer fabric softeners

Dryer fabric softeners are recommended for reducing static cling and for softening fabrics. Always follow package instructions carefully.

**NOTE:** Static can also be reduced by not overdrying.

- For best results, put fabric softener sheet on top of the load **before starting the dryer**. **DO NOT** add a fabric softener sheet **after** the cycle has started. Instant heat can cause the fabric softener to spot fabrics.
- Clear, grease-like spots can result from the fabric softener sheet becoming tangled or wrapped in an item during tumbling. If fabric softener causes a stain, wet the stain and rub with liquid detergent or bar soap then wash.
- Some dryer fabric softeners can clog the lint screen and slow drying. Use only fabric softeners labeled as dryer safe.

---

## Energy saving tips

- Dry only full loads without overdrying.
- Avoid overloading dryer, adding wet items to a partly dried load, or opening the door unnecessarily.
- Plan your laundry to dry one load after another. A warm dryer shortens drying time.
- Shorten drying times by:
  - keeping the lint screen clean.
  - using your dryer in a room where room air temperature is above 45°F (7°C).
  - exhausting dryer properly.
  - sorting loads by fabric weight and type.

---

## Vacation care

1. Unplug power supply cord or turn off electrical power supply. Shut off supply GAS VALVE if you have a gas dryer.
2. Clean lint screen.

# If You Need Assistance Or Service

This section is designed to help you save the cost of a service call. First we outline possible problems, their causes and their solutions. However, you may still need assistance or service. When calling our Consumer Assistance Center for help or calling for service, you will need to provide a complete description of the problem, your appliance's complete model and serial numbers and the purchase date. (See page 2.) This information is needed to respond to your request properly.

## 1. Before calling for assistance ...

Performance problems often result from little things you can find and fix without tools of any kind. Please check the chart below for problems you can fix. It could save you the cost of a service call.

PROBLEM	CHECK IF	SOLUTION
<p><b>Dryer will not run.</b></p>	<p>Power cord is plugged into a live circuit with proper voltage.</p> <p>Dryer door is closed. Start button is pushed firmly. Controls are set in a running or ON position. Home's main fuse has blown or circuit breaker has tripped. Also check if a time-delay fuse or circuit breaker has been used.</p>	<p>Turn cycle control knob to OFF. Firmly plug cord into electrical outlet. Check circuit voltage at fuse/circuit breaker box. Reset controls and push start button.</p> <p>Close door firmly. Push start button. Set controls and push start button.</p> <p>Turn cycle control knob to OFF. Replace fuse with a time-delay fuse of the correct capacity. Reset circuit breaker. Reset controls and push start button.</p>
<p><b>Dryer will not heat.</b></p>	<p>Cycle control knob or temperature selector is set on NO HEAT FLUFF. Heat cycle is in its last minutes (there is no heat during that time).</p> <p>Home's main fuse has blown or circuit breaker has tripped. Also check if a time-delayed fuse or circuit breaker has been used.</p> <p>Gas shutoff valves are open both on dryer and on supply line if yours is a gas dryer.</p>	<p>Reset cycle control knob or temperature selector to heat setting. Wait for cycle to finish.</p> <p>Turn cycle control knob to OFF. Replace fuse with a time-delayed fuse of the correct capacity. Reset circuit breaker. Reset controls and push start button.</p> <p>The circuit supplying an electric dryer uses 2 breakers or 2 fuses. If one breaker has tripped or one fuse has blown, the dryer may run, but not heat. Turn cycle control knob to OFF. Open gas valves. Wait 5 minutes. Reset controls and push start button.</p>
<p><b>Drying time too long.</b></p>	<p>Lint screen is clean.</p> <p>Exhaust duct or outside exhaust hood is clogged.</p>	<p>Clean lint screen. See instructions on page 13.</p> <p>See "Slow drying" section of table, page 18, for additional information.</p> <p>Clean if needed.</p>

## **2. If you need assistance ...**

Call our toll-free telephone number. Dial free from anywhere in the U.S.:

**1-800-44-ROPER  
(1-800-447-6737)**

and talk with one of our trained consultants. The consultant can instruct you in how to obtain satisfactory operation from your appliance or, if service is necessary, recommend a qualified service company in your area.

For further information, write to:

Mr. William Clark  
Consumer Assistance Representative  
Roper Brand Appliances  
2000 M-63  
Benton Harbor, MI 49022

Please include a daytime phone number in your correspondence.

## **3. If you need service ...**

Contact the dealer from whom you purchased the appliance or the authorized servicer in your area. For help finding an authorized servicer in your area, call our toll-free telephone number in Step 2.

## **4. If you are not satisfied with how the problem was solved ...**

- Contact the Major Appliance Consumer Action Panel (MACAP). MACAP is a group of independent consumer experts that voices consumer views at the highest levels of the major appliance industry.
- Contact MACAP only when the dealer, authorized servicer and Roper Brand Appliance warrantor have failed to resolve your problem.  
Major Appliance Consumer Action Panel  
20 North Wacker Drive  
Chicago, IL 60606
- MACAP will in turn inform us of your action.





# ROPER® Dryer Warranty

LENGTH OF WARRANTY	WHAT WE WILL PAY FOR
<b>FULL ONE-YEAR WARRANTY</b> (from date of purchase)	Replacement parts and repair labor to correct defects in materials or workmanship.  Service must be provided by an authorized Roper service company.
<b>WHAT WE WILL NOT PAY FOR</b>	
<p><b>A. Service calls to:</b></p> <ol style="list-style-type: none"> <li>1. Correct the installation of your appliance.</li> <li>2. Instruct you how to use your appliance.</li> <li>3. Replace house fuses or correct house wiring or plumbing.</li> <li>4. Replace owner accessible light bulbs.</li> </ol> <p><b>B. Repairs when appliance is used in other than normal, single-family household use.</b></p> <p><b>C. Pickup and delivery. Your appliance is designed to be repaired in the home.</b></p> <p><b>D. Damage to appliance caused by accident, misuse, fire, flood, acts of God, or use of products not approved by us.</b></p> <p><b>E. Repairs to parts or systems caused by unauthorized modifications made to the appliance.</b></p>	

This Roper appliance is warranted by Whirlpool Corporation. Under no circumstances shall it be liable under this warranty for incidental or consequential damages and all implied warranties are limited to the same time period stated in the express warranties for Roper Brand Appliances. Some states do not allow the exclusion or limitation of incidental or consequential damages, so this limitation or exclusion may not apply to you.

This warranty gives you specific legal rights, and you may also have other rights which vary from state to state.

Outside the United States, a different warranty may also apply. For details, please contact your authorized Roper distributor or military exchange.

If you need service, first see the "Assistance and Service" section of this book. After checking "Assistance and Service," additional help can be found by calling our toll-free telephone number, **1-800-44-ROPER (1-800-447-6737)**, from anywhere in the U.S.